

Fielding Worktables

Le plaisir d'être différent

orangebox



Description du produit

Les tables hautes et de travail Fielding se déclinent en dix-sept designs différents et sont conçues pour quatre à huit personnes. Sept des tables de travail Fielding comportent un plateau divisé à deux niveaux et quatre, un plateau intégral. Dans les tables hautes, on compte deux modèles de chaque type.

Sous chaque plateau Fielding une généreuse structure creuse recouverte de tissu surmonte la plateforme de plancher surélevé standard, pour abriter de nombreux câbles électriques, câbles de données et autre matériel technologique. Un panneau dissimulé permet à l'air de circuler à l'intérieur de la structure et sécurise l'accès au matériel.

Tangent à la structure creuse, un cadre en tube d'acier carré de structure élancée masque les pieds réglables, ajoute son attrait architectural au modèle et offre aux utilisateurs un espace généreux pour les jambes.

Les tables Fielding, tant à plateau divisé qu'à plateau intégral, s'accompagnent d'un éventail de modules standard Orangebox pour l'alimentation et les données en surface. À l'instar des tables BAE, elles disposent de tapes circulaires à soulever donnant accès, sous la surface, à de grands boîtiers électriques. Elles conviennent également à notre lampe à LED exclusive Pablo en option.

Deux tables médias à plateau intégral, pour quatre ou six personnes, peuvent être spécifiées avec une tour structurelle abritant soit des accessoires technologiques auxiliaires, accessibles par une grande porte sécurisée, soit un espace vestiaire ouvert, le matériel technologique étant rangé en toute sécurité dans la structure creuse sous le plateau. Les deux options sont munies de pattes de fixation standard pour grands écrans.

Les plateaux des tables Fielding sont proposés dans de multiples finitions, notamment un vaste choix de stratifiés de couleur, sept nouveaux décors métalliques, des bois lamellés raffinés et des motifs graphiques décoratifs exclusifs Orangebox. La section Services/Finitions de ce site Internet fournit des informations détaillées sur toutes ces finitions.

Les tables Fielding confèrent aux espaces de travail une diversité plus riche, vivante et dynamique. Elles sont extrêmement pratiques et conçues pour favoriser la concentration et la productivité au travail. L'architecture des tables et les formes des plateaux ont été étudiées spécialement pour refléter la variété et la vitalité d'un bureau contemporain et de ses utilisateurs et distinguent totalement les créations Fielding des tables conventionnelles.

Image FIELDING-13



Haut - FIELDING-05, Bas - FIELDING-02



Bandrol ~~de~~aproduits

FIELDING-01
Long stop medium

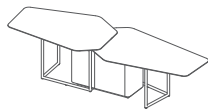

H750 [H30]
TH750 & 710 [TH30 & 28]
W3000 [W118] D1025 [D41]

FIELDING-02
Long stop large

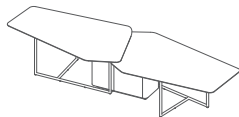

H750 [H30]
TH750 & 710 [TH30 & 28]
W3815 [W150] D1320 [D52]

FIELDING-03
Fly slip medium

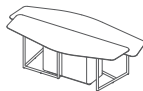

H750 [H30]
TH750 & 710 [TH30 & 28]
W2500 [W98] D1285 [D51]

FIELDING-04
Fly slip large

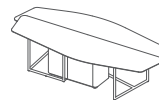

H750 [H30]
TH750 & 710 [TH30 & 28]
W2870 [W113] D1470 [D58]

FIELDING-05
Short leg small

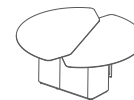

H750 [H30]
TH750 & 710 [TH30 & 28]
W1800 [W71] D1765 [D71]

FIELDING-06
Short leg medium



H750 [H30]
TH750 & 710 [TH30 & 28]
W2000 [W78] D1970 [D78]

FIELDING-07
Short leg large



H750 [H30]
TH750 & 710 [TH30 & 28]
W2380 [W109] D2360 [D109]

FIELDING-08
Mid-off medium

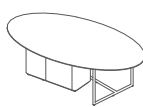

H750 [H30] TH750 [TH30]
W2400 [W93] D1280 [D50]

FIELDING-09
Mid-off large



H750 [H30] TH750 [TH30]
W2770 [W109] D1280 [D50]

FIELDING-10
Cover medium

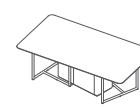

H750 [H30]
TH750 [TH30]
W2200 [W87] D1200 [D47]

FIELDING-11
Cover large

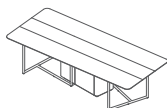

H750 [H30]
TH750 [TH30]
W2770 [W109] D1400 [D55]

FIELDING-12
Third man large

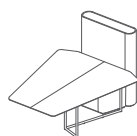

H1500 [H59]
TH750 [TH30]
W1800 [W71] D2260 [D89]

FIELDING-13
Third man small

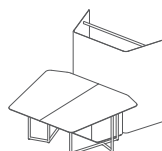

H1500 [H59]
TH750 [TH30]
W1800 [W71] D2225 [D87]

FIELDING-14
Deep square leg medium

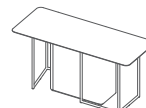

H1050 [H41]
TH1050 [TH41]
W2220 [W87] D900 [D35]

FIELDING-15
Deep square leg large

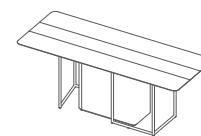

H1050 [H41]
TH1050 [TH41]
W2770 [W87] D1100 [D35]

FIELDING-16
Long leg medium

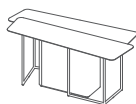

H1090 [H43]
TH1090 & 1050 [TH43 & 41]
W2450 [W96] D1200 [D47]

FIELDING-17
Long leg large

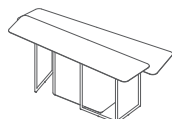

H1090 [H43]
TH1090 & 1050 [TH43 & 41]
W2760 [W109] D1295 [D1295]



Spécification de produit

Description de produit standard

Pieds en métal : Black, White, Gold, Taupe, Industrial Silver, Bronze ou Copper.

Moniteur : support de moniteur universel en série. (12 & 13)

Options de sections longitudinales :

Les stratifiés EGGER ou Fenix peuvent être utilisés seuls ou combinés.

(FIELDING 11 et 15 seulement).

Finitions de surface de table :

Stratifié : White Fleetwood, Natural Davos, Grey Arizona, Tobacco Charleston, Grey Bardolino, Fenix 2630 Piombo Doha, Fenix 0720 Nero Ingo, Fenix 0724 Grigio Bromo, Fenix 0718 Grigio Londra, Fenix 2638 Titanio Doha, Fenix 0725 Grigio Efeso.

Laminate Younique® – Modernist, Modernist 2, Modernist 3, Floral, Floral 2, Fracture, Fracture 2, Leaf, Line, Animals, Animals 2, Houndstooth, Houndstooth 2, Houndstooth 3, Houndstooth 4, 50s, 50s 2, Triangle, Triangle 2, Jaqured 2 ou Jaqured 3.

Optional Upcharges

Finitions personnalisées : Younique® par Formica Group est un stratifié haute pression avec une image imprimée personnalisée sur sa face décorative.

Alimentation : options d'alimentation sur table disponibles. Modules avec alimentation sont sujet à majoration.

Éclairage : Lampes Pablo Circa.

Kit de nettoyage Fenix : optionnel avec majoration.

Option d'alimentation et d'éclairage

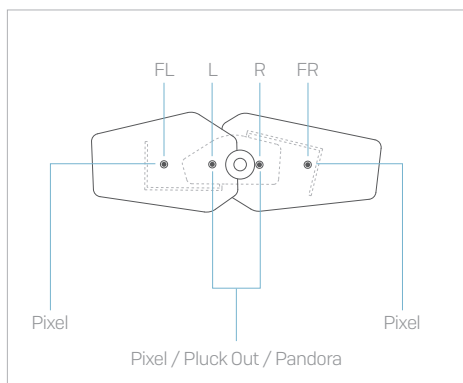

FIELDING-01

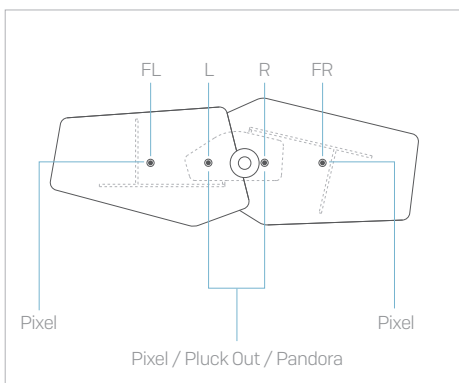

FIELDING-02

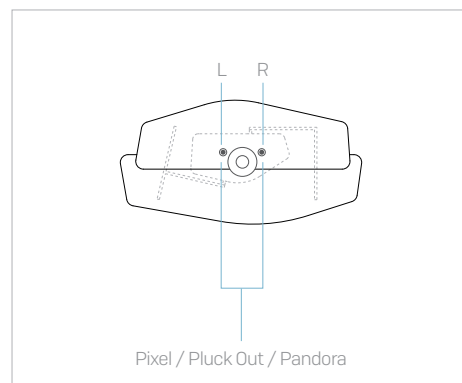

FIELDING-03

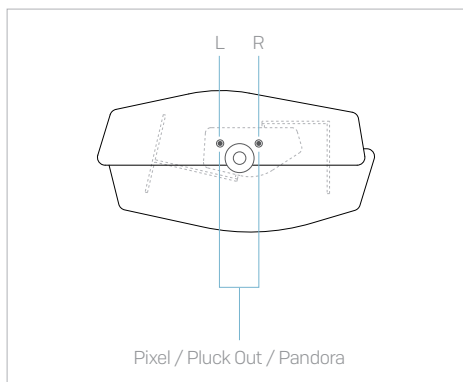

FIELDING-04

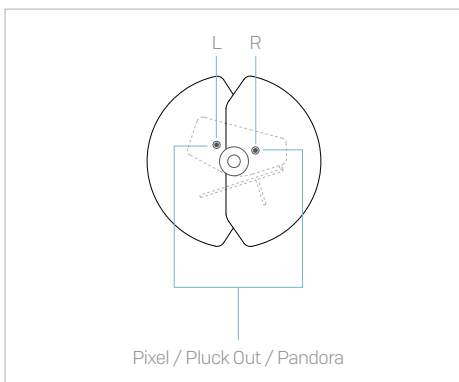

FIELDING-05

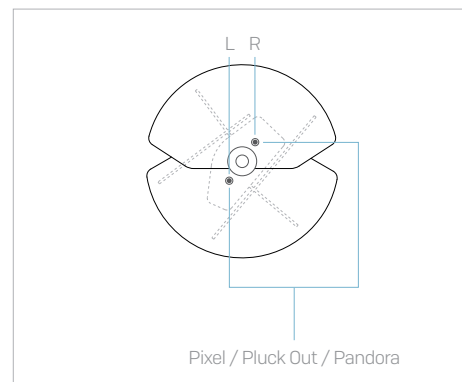

FIELDING-06

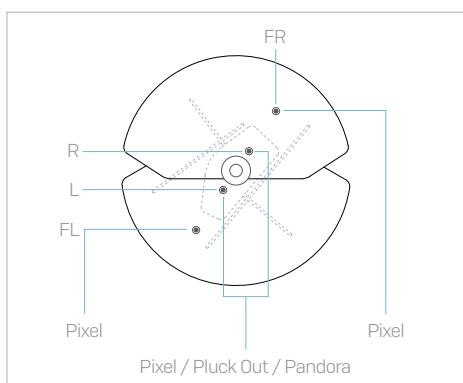

FIELDING-07

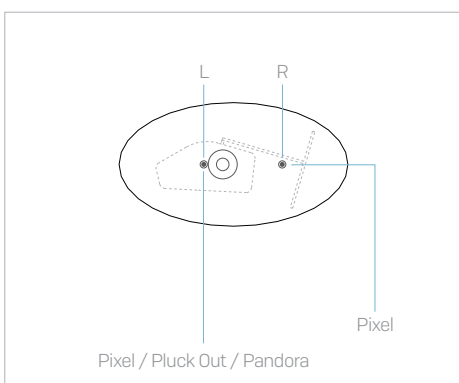

FIELDING-08

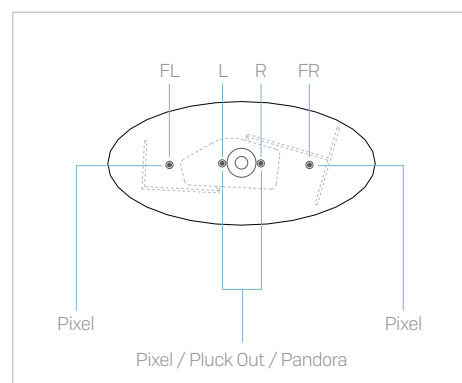

FIELDING-09

FL Unité d'alimentation extrême gauche
FR Unité d'extrême droite

L Unité d'alimentation gauche
R Unité de puissance droite

C Unité d'alimentation centrale
● Emplacement de l'unité d'alimentation

⊙ Pablo Lighting Location

Option d'alimentation et d'éclairage

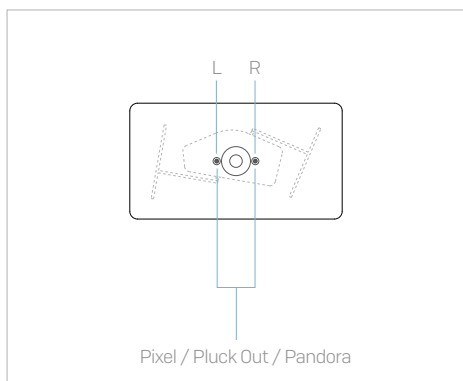

FIELDING-10

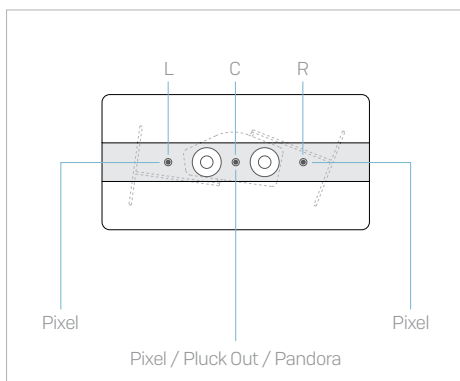

FIELDING-11

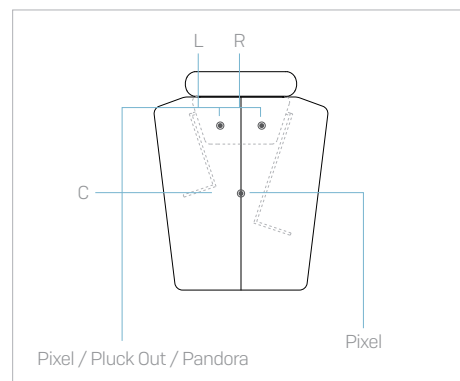

FIELDING-12

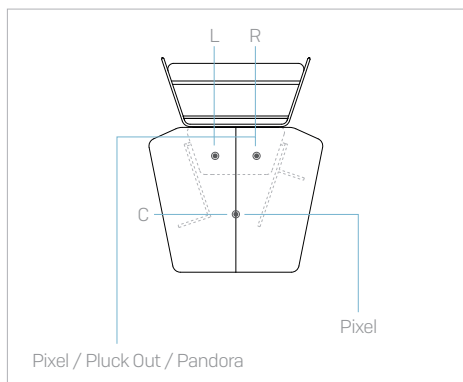

FIELDING-13

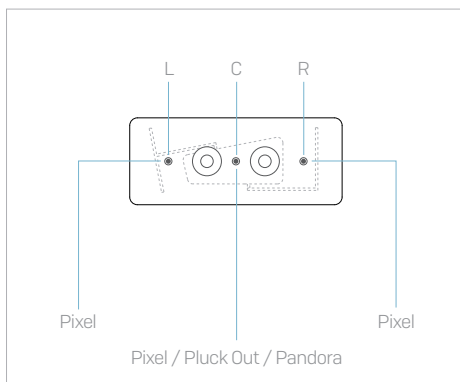

FIELDING-14

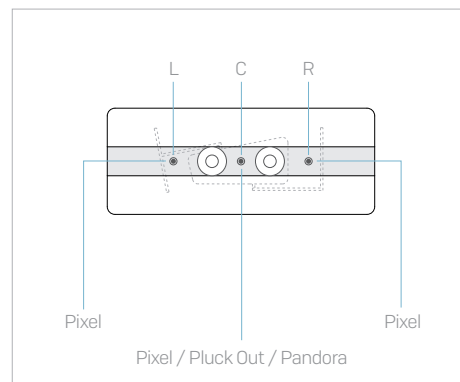

FIELDING-15

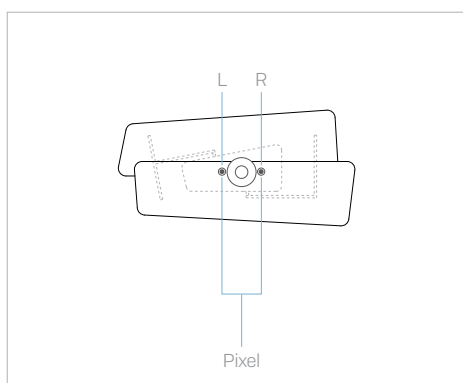

FIELDING-07

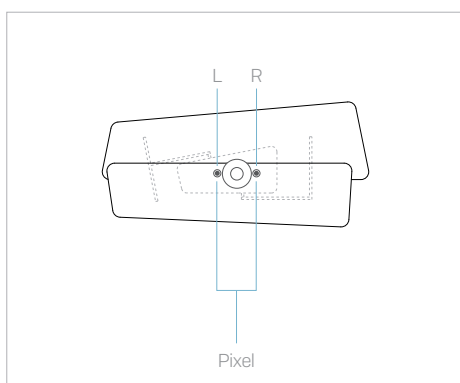

FIELDING-08

FL Unité d'alimentation extrême gauche
FR Unité d'extrême droite

L Unité d'alimentation gauche
R Unité de puissance droite

C Unité d'alimentation centrale
● Emplacement de l'unité d'alimentation

⊙ Pablo Lighting Location

Options d'alimentation



Pluck Out

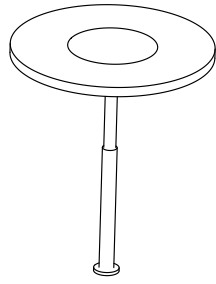

Pablo Lighting



Pandora



Pixel

Produit Finitions

Pieds en métal



Black



White



Gold

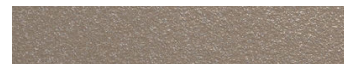

Taupe



Industrial Silver



Bronze



Copper

Surfaces de table : Stratifié



White Fleetwood



Natural Davos



Grey Arizona

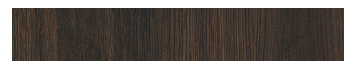

Tobacco Charleston



Grey Bardolino

Surfaces de table : Stratifié Younique® (Délais standard)



Line



Modernist 2



Floral 1



Houndstooth 1



Houndstooth 2



Houndstooth 3



Houndstooth 4

Surfaces de table : Stratifié Younique® (Délais prolongés)



Floral 2



Leaf



Animals 1



Animals 2



Fracture 1



Fracture 2



50s 1



50s 2



Triangle 1



Triangle 2



Jaquard 1



Jaquard 2



Jaquard 3



Modernist 1



Modernist 3