



Coze

A fresh take on key archetypes

orangebox



Product Description

The Coze family offers a fresh take on key archetypes for a wide variety of office and hospitality settings.

Coze's fluid curves and soft edges make for a relaxed contemporary chair that's ideal for both workplace and hospitality environments. Coze armchairs – low back lounge, high back lounge and wingback – are perfectly complemented by a generous two-seat sofa, and by the newly added meeting/ café/dining chair, an upright armchair and café stool, which share the design personality of the original collection.

Featuring a new, turned wood leg, and offering a refined sitting position enhanced by a soft and supportive back, these new pieces extend the appeal of this successful and universally applied design collection. They have been manufactured to allow designers and specifiers a wide choice of fabrics and a diversity of fabric combinations.

The fully upholstered meeting chair and armchair are both available with a choice of wood legs, four star metal trestle base or five star castor base. The café stool is likewise available with a choice of wood finishes, enhanced by a structural metal foot rail.

Image COZE-L01



Top - COZE-W03, Bottom - COZE-D01 & D02



Product Range

COZE-L01

Wing back chair



H1130 [H44]
W815 [W32] D820 [D32]

COZE-L02

Low back chair



H900 [H35]
W720 [W28] D770 [D30]

COZE-L03

High back chair



H1130 [H44]
W720 [W28] D820 [D32]

COZE-L04

2 seat lounge sofa



H900 [H35]
W1460 [W57] D770 [D30]

COZE-W01

Low back sofa



H955 [H38]
W1580 [W62] D720 [D28]
SH455 [SH18] SD485 [SD19]

COZE-W02

High back sofa



H1265 [H50]
W1580 [W62] D720 [D28]
SH455 [SH18] SD485 [SD19]

COZE-W03

Workbooth

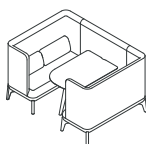

H1265 [H50]
W2130 [D84] D1580 [W62]
SH455 [SH18] SD485 [SD19]

COZE-D01

Non-armed chair turned leg



H800 [H31]
W576 [21] D594 [W23]
SH470 [SH19] SD440 [SD17]

COZE-D02

Armchair turned leg



H800 [H31]
W540 [D21] D594 [W23]
SH470 [SH19] SD440 [SD17]

COZE-D03

Non-armed chair 4 star base



H800 [H31]
W700 [D28] D700 [W28]
SH470 [SH19] SD440 [SD17]

COZE-D04

Armchair 4 star base



H800 [H31]
W700 [D28] D700 [W28]
SH470 [SH19] SD440 [SD17]

COZE-D05

Non-armed chair 5 star base



H800 [H31]
W690 [D27] D690 [W27]
SH470 [SH19] SD440 [SD17]

COZE-D06

Armchair 5 star base



H800 [H31]
W690 [D27] D690 [W27]
SH470 [SH19] SD440 [SD17]

COZE-D07

Bar stool turned leg



H1020 [H40]
W506 [D20] D470 [W19]
SH770 [SH30] SD385 [SD15]



Top - COZE-D04, **Bottom** - COZE-L02



Product Specification – L01 - L04

Standard Product Description

Frame: Oak frame as standard.

Back: Plain back as standard. (L02, L04)

Fabric: Fabric pull available at no additional cost. (Fly Detail)

Buttons: Buttons as standard. Available at no additional cost. (L02, L04)

Contrasting Buttons at no additional cost on all models.

Buttons to match inner back material as standard, contrasting button available on 2 tone fabric only and must match the second fabric choice.

Optional Upcharges

Frame: Oak stained to Walnut, Beech, Black or Dark Distressed Oak.

Upholstery: Two Tone Upholstery available as an upcharge.

Armpads: Leather Armpads (Black or Brown). Available in Highland Black or Highland Whisky.

Headrest: Leather Headrest (Black or Brown) (L03). Available in Highland Black or Highland Whisky.

Product Certification

Intertek Sustainability Clean Air Product Certification

Clean Air certification provides proof that products have been independently tested and found to conform to VOC standards and to the ANSI/ BIFMA Furniture Emissions Standards. All Orangebox products* have achieved Gold certification, excluding laminate products which achieve a Silver certification.

*With the exception of Fielding Tables.

BS EN 1022:2005

Domestic Furniture - Determination of stability.

BS EN 16139:2013

Test Level 1 - Furniture - Strength, durability and safety. Requirements for non-domestic seating.

Product Specification – W01 - W03

Standard Product Description

Frame: Oak frame as standard.

Buttons: Buttons as standard or no Buttons at no additional cost.

Buttons to match inner back material as standard, contrasting button available on 2 tone fabric only and must match the second fabric choice.

Optional Upcharges

Frame: Oak stained to Walnut, Beech, Black or Dark Distressed Oak.

Upholstery: Internal or External Two Tone Upholstery available as an upcharge.

Table Top Finishes: Available on W03.

Melamine – Walnut, Grained Oak, Artisan Oak, Beech, Graphite, White or Grey.

Laminate – White Fleetwood, Natural Davos, Grey Arizona, Tobacco Charleston or Grey Bardolino.

Laminate Fenix – 2630 Pimobo Doha, 0720 Negro Ingo, 0724 Grigio Bromo, 0718 Grigio Londra, 2638 Titanio Doha, 0725 Grigio Efeso, 0030 Bianco Alaska.

Power: Power options available.

Base Power options. (W01, W02, W03)

Table Power options. (W03)

Screen Power options. (W03)

Monitor: Tilting Monitor Bracket (TMB-01) available on W03.

Fenix Cleaning Kit: Available to order as an upcharge.

Product Certification

Intertek Sustainability Clean Air Product Certification

Clean Air certification provides proof that products have been independently tested and found to conform to VOC standards and to the ANSI/ BIFMA Furniture Emissions Standards. All Orangebox products* have achieved Gold certification, excluding laminate products which achieve a Silver certification.

*With the exception of Fielding Tables.

BS EN 16139:2013

Test Level 1 - Furniture - Strength, durability and safety. Requirements for non-domestic seating.

Product Specification – D01 - D07

Standard Product Description

Frame: Oak frame as standard. (D01, D02, D07)

Glides: Glides as standard. (D03, D04)

Castors: 65mm Hard Black Castors as standard. (D05, D06)

Base: Trestle Base available in Polished or Black (D03, D04)

5 Star Base: 5 Star Base available in Polished or Black. (D05, D06)

Foot Rail: Black foot rail as standard. (D07)

Optional Upcharges

Frame: Oak stained to Walnut, Beech, Black or Dark Distressed Oak. (D01, D02, D07)

Glides: Soft Glides available as an upcharge. (D03, D04)

Castors: 65mm Chrome Castors available as an upcharge. (D05, D06)

Upholstery: Two tone upholstery available as an upcharge.

Product Certification

Intertek Sustainability Clean Air Product Certification

Clean Air certification provides proof that products have been independently tested and found to conform to VOC standards and to the ANSI/ BIFMA Furniture Emissions Standards. All Orangebox products* have achieved Gold certification, excluding laminate products which achieve a Silver certification.

*With the exception of Fielding Tables.

BS EN 16139:2013

Test Level 1 - Furniture - Strength, durability and safety. Requirements for non-domestic seating.

Fabric Selection - L01 - L04

Two Tone Upholstery

When selecting this option the two fabrics should be from the same family.

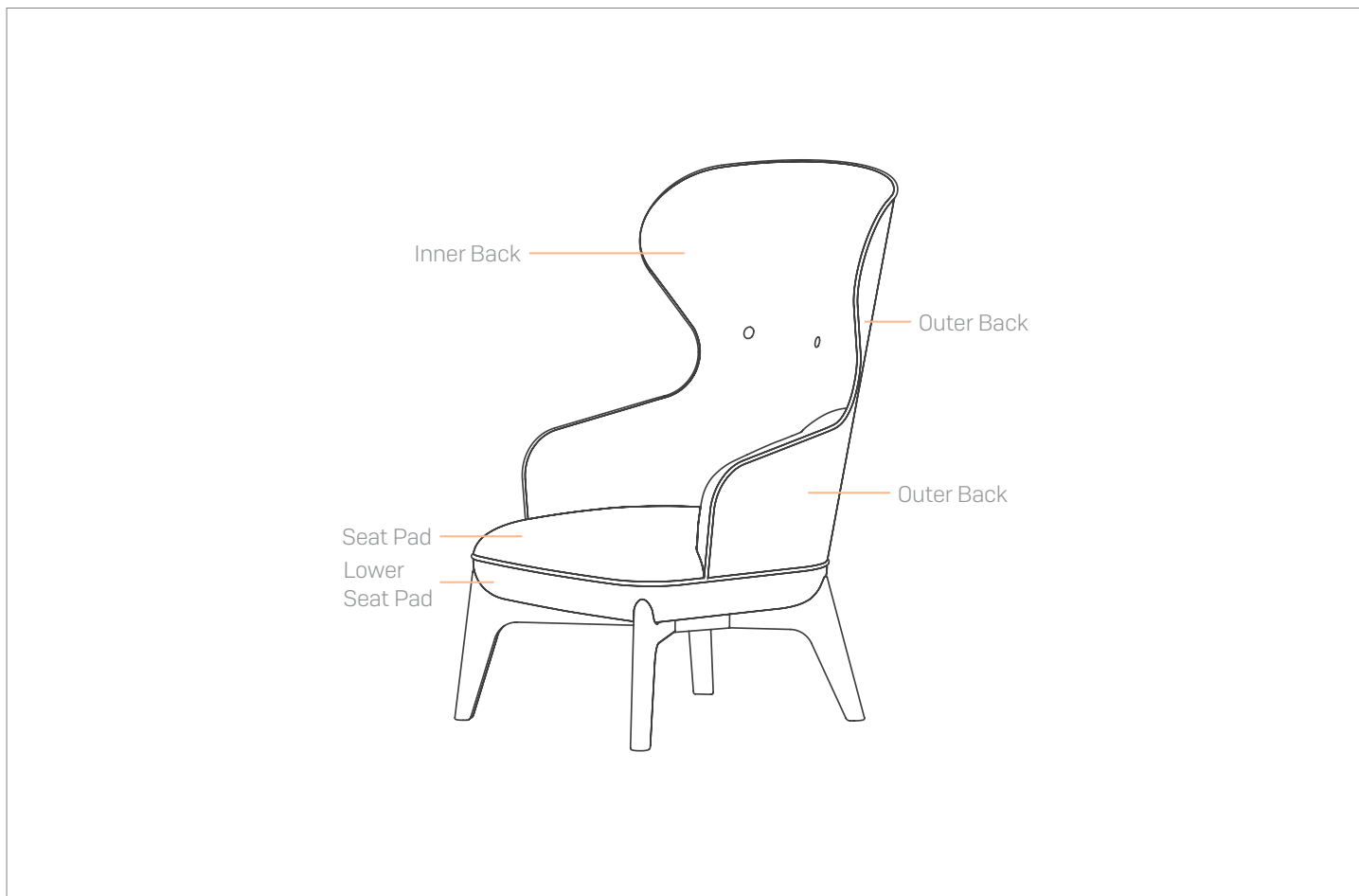

Option 1

Inner back and seat pad are the same fabric. Outer back and lower seat pad can be a different fabric.

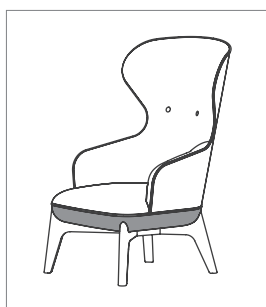

Option 2

Inner and outer back, seat pad and lower seat pad are the same fabric. Lower seat pad can be a different fabric.

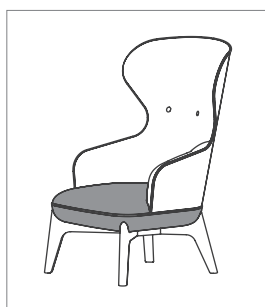

Option 3

Inner and outer back are the same fabric. Seat pad and lower seat pad can be a different fabric.

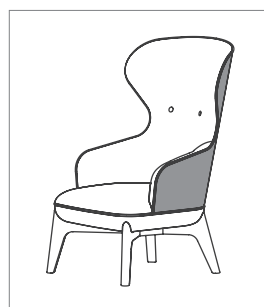

Option 4

Inner back, seat pad and lower seat pad are the same fabric. Outer back can be a different fabric.

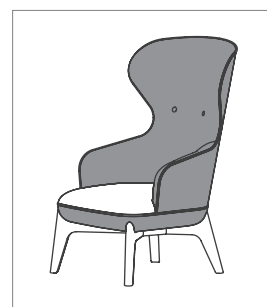

Option 5

Inner and outer back and lower seat pad are the same fabric. Seat pad can be a different fabric.

Fabric Selection – W01 - W03

Two Tone Upholstery

When selecting this option the two fabrics should be from the same family.

Option 1 - Standard Upholstery

All fabrics or leathers provided they are from the same range or have very similar properties.

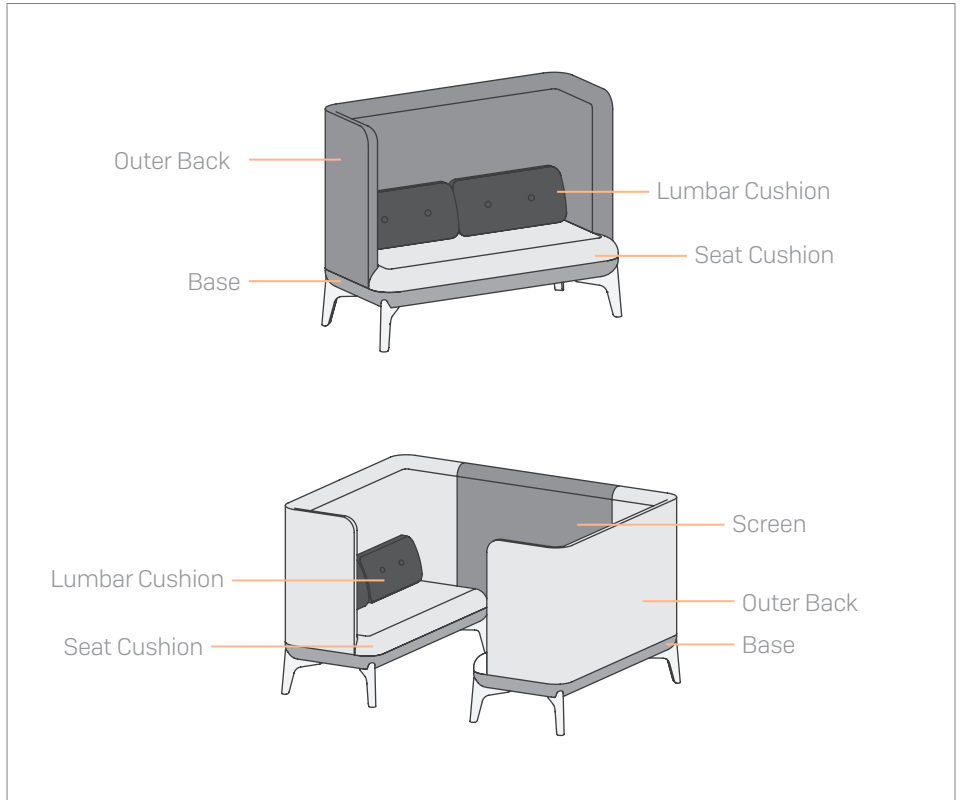

Option 2 - Inner/Outer Splits

All fabrics or leathers provided they are from the same range or have very similar properties.

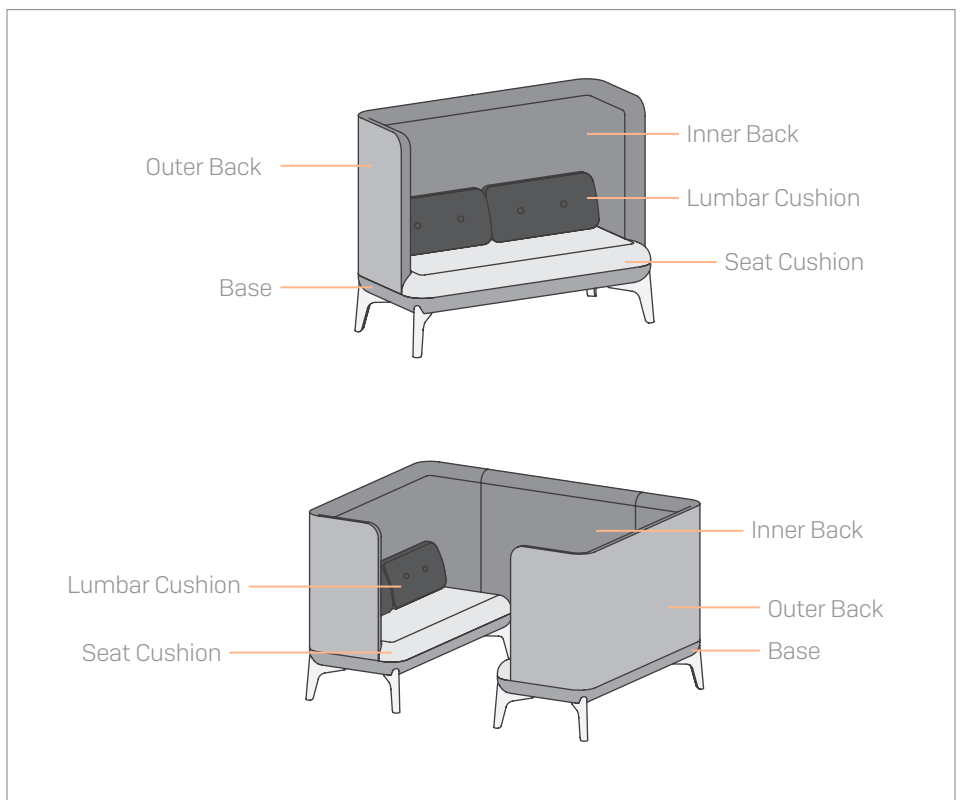

Fabric Selection – D01 - D07

Two Tone Upholstery

When selecting this option the two fabrics should be from the same family.

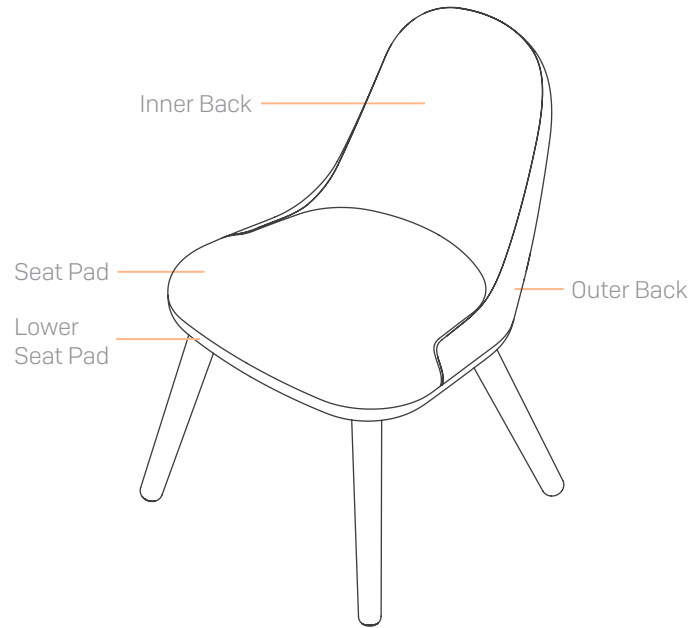

Option 1

Inner and outer back and seat pad are the same fabric. Lower seat pad can be a different fabric.



Option 2

Inner back and seat pad are the same fabric. Lower seat pad and outer back can be a different fabric.

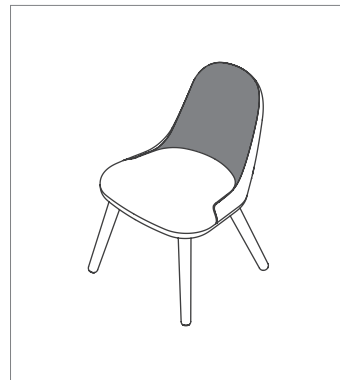

Option 3

Seat pad, lower seat pad and outer back are the same fabric. Inner back can be a different fabric.

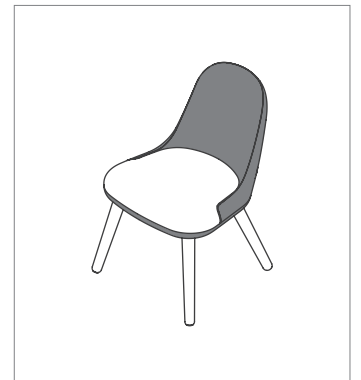

Option 4

Inner and outer back and lower seat pad are the same fabric. Seat pad can be a different fabric.

Product Finishes

Oak Frame (L01, L02, L03, L04, W01, W02, W03, D01, D02, D07)

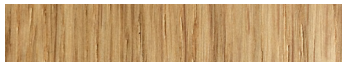

Oak

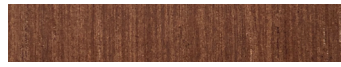

Oak stained to Walnut

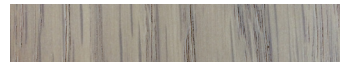

Oak stained to Beech



Oak stained to Black



Dark Distressed Oak

Table Tops — Melamine (W03)



Walnut



Grained Oak



Artisan Oak



Beech



Graphite



Grey



White

Table Tops — Laminate (W03)



White Fleetwood



Natural Davos

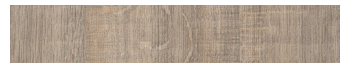

Grey Arizona

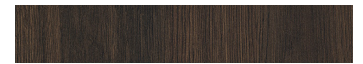

Tobacco Charleston

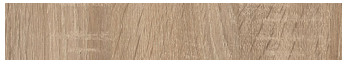

Grey Bardolino



Fenix 2630 Piombo Doha



Fenix 0720 Nero Ingo



Fenix 0724 Grigio Bromo



Fenix 0718 Grigio Londra



Fenix 2638 Titanio Doha



Fenix 0725 Grigio Efeso



Fenix 0030 Bianco Alaska

Armpads & Headrest (L01, L02, L03)



Highland Black



Highland Whisky

Castors (D05, D06)



Black



Chrome

5 Star Base (D05, D06)



Polished



Black