



Border

A low & high liner
upholstered bench

orangebox



Product Description

As its name suggests, Border provides a neat way of dividing up spaces. Its simplicity and precise modularity has ensured its continuous success in diverse spaces in both café areas and within varied open-plan spaces.

The liner design combines an upholstered bench and a worktable at both work and café height, allowing the unit to be combined with complementary Smartworking and Network Landscape chairs and stools. The table structure at both heights has an integrated pullout power/data module, enabling it to become an effective additional work area.



Top - BORDER-02, Bottom - BORDER-05



Product Range

BORDER-01

Low seat single unit
Ø800mm table

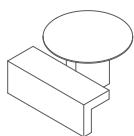

H760 [H30]
W1200 [W47] D1065 [D42]
SH445 [SH18] SD400 [SD16]
TH750 [TH30]

BORDER-02

Low seat double unit
Ø800mm table

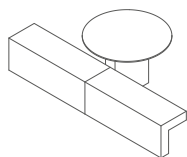

H760 [H30]
W2400 [W94] D1065 [D42]
SH445 [SH18] SD400 [SD16]
TH750 [TH30]

BORDER-03

High seat single unit, left hand
Ø800mm table

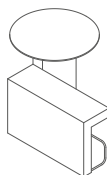

H1070 [H42]
W1200 [W47] D1065 [D42]
SH755 [SH30] SD400 [SD16]
TH1060 [TH42]

BORDER-04

High seat single unit, right hand
Ø800mm table

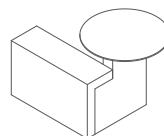

H1070 [H42]
W1200 [W47] D1065 [D42]
SH755 [SH30] SD400 [SD16]
TH1060 [TH42]

BORDER-05

High seat double unit
Ø800mm table

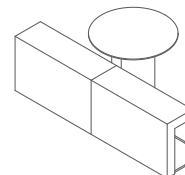

H1070 [H42]
W2400 [W94] D1065 [D42]
SH755 [SH30] SD400 [SD16]
TH1060 [TH42]



Product Specification

Standard Product Description

Frame: 100% FSC plywood.

Foam: Vitaform Reflex.

Edge Detail: Ø800mm top with Square Edge as standard.

Edge Finish: 2mm thick ABS liping match to top colour.

Foot Rail: Tubular Steel, Chromed. (03, 04, 05 only)

Table Top Finishes:

Melamine – Walnut, Grained Oak, Artisan Oak, Beech, Graphite, White or Grey.

Optional Upcharges

Table Top Finishes: Laminate Table Tops available as an upcharge.

Laminate – White Fleetwood, Natural Davos, Grey Arizona, Tobacco Charleston or Grey Bardolino.

Laminate Fenix – 2630 Pimobo Doha, 0720 Negro Ingo, 0724 Grigio Bromo, 0718 Grigio Londra, 2638 Titanio Doha, 0725 Grigio Efeso, 0030 Bianco Alaska.

Edge Detail:

Ø1000mm top with Square Edge, Ø800mm top with Chamfered Edge or Ø1000mm top with Chamfered Edge.

Upholstery: Two Tone Upholstery available

Power: Power/Data options available.

Product Certification

Intertek Sustainability Clean Air Product Certification

Clean Air certification provides proof that products have been independently tested and found to conform to VOC standards and to the ANSI/ BIFMA Furniture Emissions Standards. All Orangebox products* have achieved Gold certification, excluding laminate products which achieve a Silver certification.

*With the exception of Fielding Tables.

Table Finishes

Edge Details

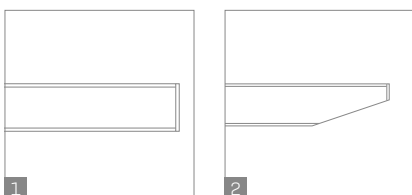

1. 25mm Square Edge
2. 25mm Chamfered Edge

Fabric Selection

Two Tone Upholstery

When selecting this option the two fabrics should be from the same family.
Seat and base can be different fabrics or leathers.

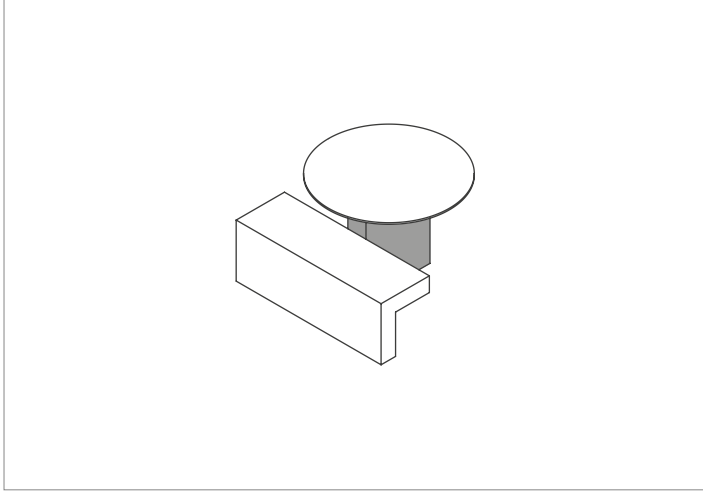

Product Finishes

Foot Rail



Chrome

Table Tops — Melamine

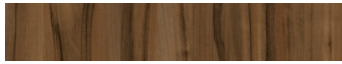

Walnut



Grained Oak



Artisan Oak



Beech



Graphite

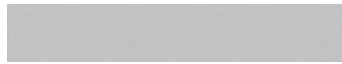

Grey



White

Table Tops — Laminate



White Fleetwood



Natural Davos



Grey Arizona



Tobacco Charleston



Grey Bardolino



Fenix 2630 Piombo Doha



Fenix 0720 Nero Ingo



Fenix 0724 Grigio Bromo



Fenix 0718 Grigio Londra



Fenix 2638 Titanio Doha



Fenix 0725 Grigio Efeso



Fenix 0030 Bianco Alaska