

---

# BuzziMilk

## product specification sheet

---

This documents contains technical information about the BuzziMilk Stool, Counter, Bar, Bench, Stool All Wood, Tile Small, Tile Large, Side Table, Side Table Large, Table

---



[www.buzzi.space](http://www.buzzi.space)



## A classic milk stool

This rustic-meets-modern take on the old farmhouse favorite would even make your grandma feel nostalgic. BuzziMilk is a sturdy little stool inspired by elements not usually found in a standard office space. Its goal? Create a warm and homey feeling at work. BuzziMilk has four legs and an upholstered seat for a softer experience. Select from a variety of wood finishes and make it your own by pairing with one of our many BuzziSpace fabrics. Whether you choose a bold pop of color (red, yellow, green, white and blue) or a natural neutral, it is designed to stand on its own or match the BuzziPicNic table. Looking for a pure wood stool? BuzziMilk Stool Allwood is pure simplicity and strong design.





## A versatile little table

The BuzziMilk base has inspired the handy BuzziMilk Tables. They can be grouped together to create a series of coffee or side tables, or used independently. Like the BuzziMilk design, multiple size and color options are possible.

Design by Alain Gilles

---

## General

-  BuzziMilk Stool, Counter, Bar, Bench, Stool All Wood, Tile Small, Tile Large, Side Table, Side Table Large, Table
-  Frame: Wood
-  Dry usage
-  Assembled

---

## Content

Configurations	3
Components	7
Fabrics	8
Finishes	13
Dimensions	14

# Configurations

---

## BuzziMilk Stool

📌 Stool

Frame in Ash Natural, Ash Black Stained, Ash White Wash, Walnut, Oak, Ash Lacquered Blue, Ash Lacquered Green, Ash Lacquered Red, Ash Lacquered Yellow or Ash Lacquered White

🌲

Filling in C43170 foam

Seat upholstered in Fabric, Rough, Trevira CS+ | CS, Revive 1, Revive 2, Terra, Clara 2, Remix 2, Velvet, Tartan, Hero, Tonus 4, Tonus Meadow, Memory 2, Matrix or Leather Vegetal

✂️

Stool: Ø 39 cm    H 47,5 cm  
          Ø 15.35"    H 18.70"

⚖️

Stool: ± 5,9 kg | ± 13.01 lbs  
Max. weight capacity: 100 kg | 220.46 lbs

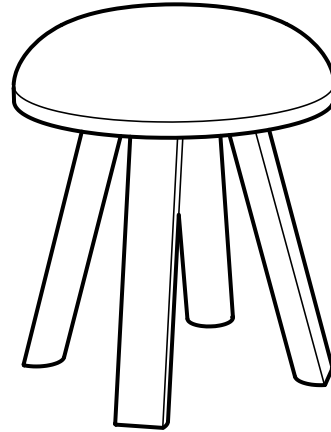

---

## BuzziMilk Counter

📌 Counter

Frame in Ash Natural, Ash Black Stained, Ash White Wash, Walnut, Oak, Ash Lacquered Blue, Ash Lacquered Green, Ash Lacquered Red, Ash Lacquered Yellow or Ash Lacquered White

🌲

Filling in C43170 foam

Seat upholstered in Fabric, Rough, Trevira CS+ | CS, Revive 1, Revive 2, Terra, Clara 2, Remix 2, Velvet, Tartan, Hero, Tonus 4, Tonus Meadow, Memory 2, Matrix or Leather Vegetal

✂️

Counter: Ø 39 cm    H 68 cm  
          Ø 15.35"    H 25.59"

⚖️

Counter: ± 7,2 kg | ± 13.01 lbs  
Max. weight capacity: 100 kg | 220.46 lbs

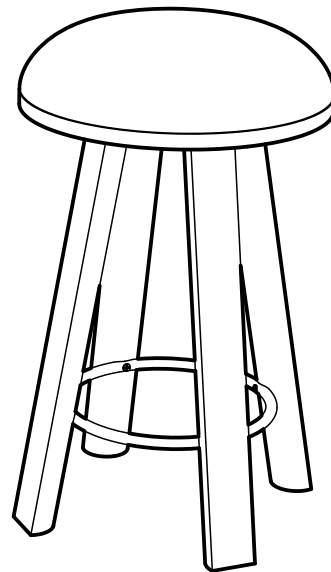

---

## BuzziMilk Bar

📌 Bar

Frame in Ash Natural, Ash Black Stained, Ash White Wash, Walnut, Oak, Ash Lacquered Blue, Ash Lacquered Green, Ash Lacquered Red, Ash Lacquered Yellow or Ash Lacquered White



Filling in C43170 foam

Seat upholstered in Fabric, Rough, Trevira CS+ | CS, Revive 1, Revive 2, Terra, Clara 2, Remix 2, Velvet, Tartan, Hero, Tonus 4, Tonus Meadow, Memory 2, Matrix or Leather Vegetal



Bar: Ø 39 cm    H 78 cm  
Ø 15.35"    H 30.71"



Bar: ± 7,8 kg | ± 17.20 lbs  
Max. weight capacity: 100 kg | 220.46 lbs

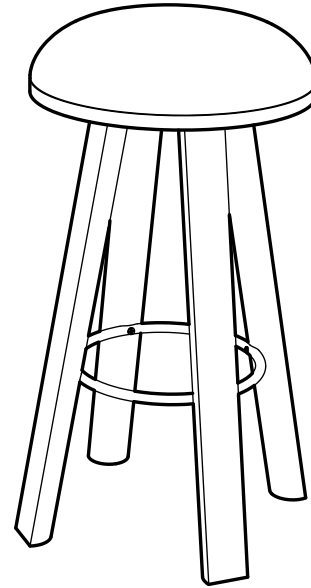

---

## BuzziMilk Bench

📌 Bench

Frame in Ash Natural, Ash Black Stained, Ash White Wash, Walnut, Oak, Ash Lacquered Blue, Ash Lacquered Green, Ash Lacquered Red, Ash Lacquered Yellow or Ash Lacquered White



Filling in C43170 foam

Seat upholstered in Fabric, Rough, Trevira CS+ | CS, Revive 1, Revive 2, Terra, Clara 2, Remix 2, Velvet, Tartan, Hero, Tonus 4, Tonus Meadow, Memory 2, Matrix, Leather Vegetal



Bench: W 39 cm    L 119 cm    H 48 cm  
W 15.35"    L 46.85"    H 18.89"



Bench: ± 14,6 kg | ± 32.19 lbs  
Max. weight capacity: 150 kg | 330.69 lbs

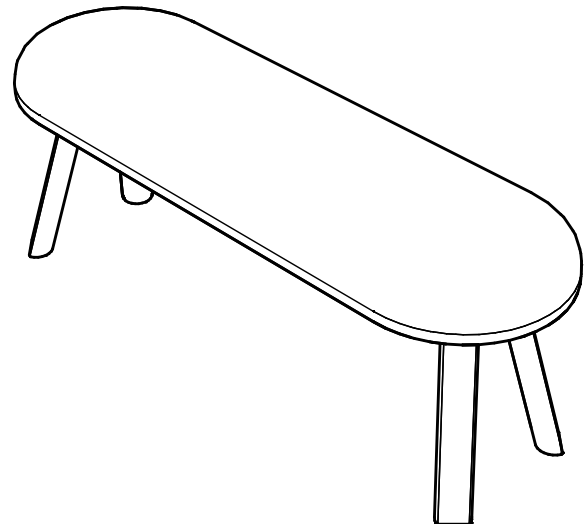

---

## BuzziMilk Stool All Wood

📌 Stool All Wood

Frame in Ash Natural, Ash Black Stained,  
Ash White Wash, Walnut, Oak,

🌲 Ash Lacquered Blue, Ash Lacquered Green,  
Ash Lacquered Red, Ash Lacquered Yellow or  
Ash Lacquered White

✂ Stool : Ø 39 cm H 43 cm  
Ø 15.35" H 16.93"

⚖ Stool: ± 6,5 kg | 14.33 lbs  
Max. weight capacity: 100 kg | 220.46 lbs

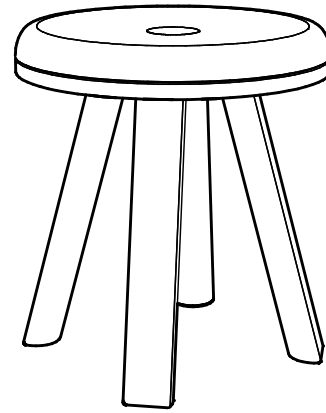

---

## BuzziMilk Tile Small

📌 Tile Small

Backplate 1,2 cm | 0.47" MDF  
Filling in C43170 foam

🌲 Upholstered in Fabric, Rough,  
Trevira CS+ | CS, Revive 1, Revive 2,  
Terra, Clara 2, Remix 2, Velvet, Tartan, Hero,  
Tonus 4, Tonus Meadow, Memory 2, Matrix or  
Leather Vegetal

✂ Ø 39 cm H 7,5 cm  
Ø 15.35" H 2.95"

⚖ ± 1,30 kg  
± 2.87 lbs

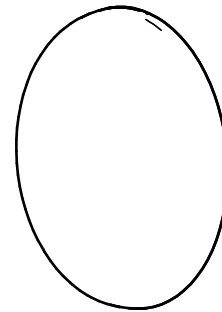

---

## BuzziMilk Tile Large

📌 Tile Large

Backplate 1,2 cm | 0.47" MDF  
Filling: C43170 foam

🌲 Upholstered in Fabric, Rough,  
Trevira CS+ | CS, Revive 1, Revive 2,  
Terra, Clara 2, Remix 2, Velvet, Tartan, Hero,  
Tonus 4, Tonus Meadow, Memory 2, Matrix or  
Leather Vegetal

✂ W 39 cm L 119 cm H 7,5 cm  
W 15.35" L 46.85" H 2.95"

⚖ ± 4,8 kg  
± 10.58 lbs

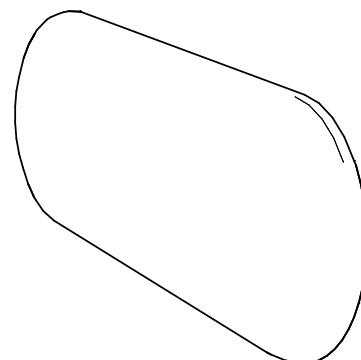

---

## BuzziMilk Side Table

Side Table

Frame in Ash Natural, Ash Black Stained,  
Ash White Wash, Walnut, Oak

Ø 39 cm H 39 cm  
Ø 15.35" H 15.35"

Side Table: ± 4,1 kg | ± 9.04 lbs  
Max. weight capacity: 100 kg | 220.46 lbs

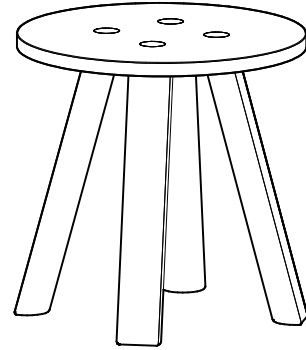

---

## BuzziMilk Side Table Large

Side Table Large

Frame in Ash Natural, Ash Black Stained,  
Ash White Wash, Walnut, Oak

W 39 cm L 119 cm H 39,5 cm  
W 15.35" L 46.85" H 15.55"

Side Table Large : ± 8,1 kg | ± 17.86 lbs  
Max. weight capacity: 50 kg | 110.23 lbs

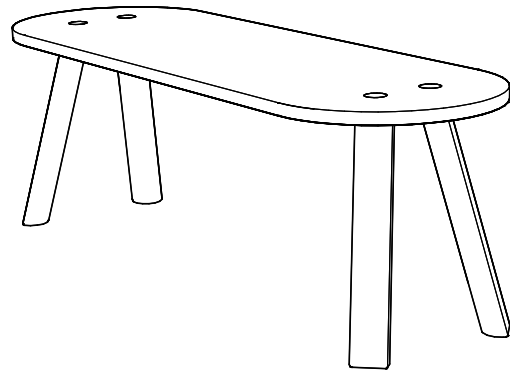

---

## BuzziMilk Table

Table

Frame in Ash Natural, Ash Black Stained,  
Ash White Wash, Walnut, Oak

Ø 100 cm H 73,5 cm  
Ø 39.37" H 28.94"

Table: 36 kg | 97.37 lbs

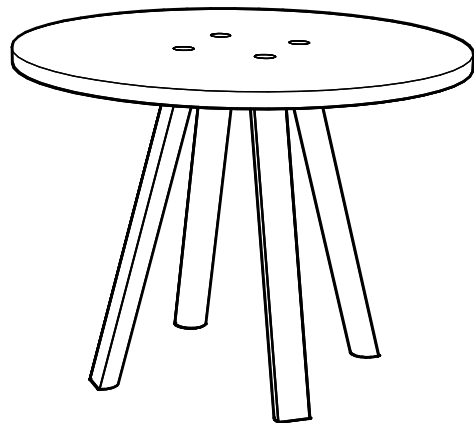

# Components



BuzziMilk has Felt or Plastic inserts



Black powder coated metal connection



BuzziMilk Tile Fixing System.  
1 pcs for Tile Small  
3 pcs for Tile Large (horizontal or vertical mounting)

# Fabrics

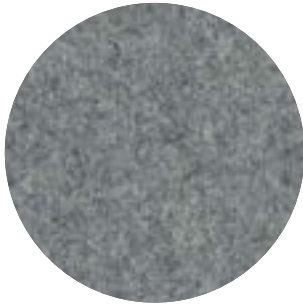

**Category A**

**Composition** 70% Recycled Wool, 25% Recycled Polyacryl,  
5% Recycled Other Fabrics

**Weight** 405 g/m<sup>2</sup> | 11.94 oz/yd<sup>2</sup>

**Abrasion resistance** 40.000 Martindale, 50,000 Wyzenbeek

**Flammability** EU: EN 1021.1/2006 | BS EN 1021.1/2006 (cigarette).  
EN 1021.2/2006 | BS EN 1021.2/2006 (match)  
USA: CAL TB 117 | ASTM E84 CLASS A

**Fastness to light** EU: 4 | USA 4

**Fastness to rubbing** EU: Wet 3-4 | Dry 4-5

**Fastness to crocking** USA: Wet 5 | Dry 5



---

## Rough

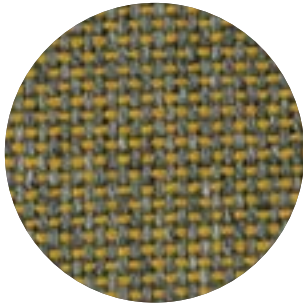

**Category A**

**Composition** 100% Polyacryl

**Weight** 456 g/m<sup>2</sup> | 13.45 oz/yd<sup>2</sup>

**Abrasion resistance** 40.000 Martindale

**Flammability** EU: EN 1021.1/2006 | BS EN 1021.1/2006 (cigarette)  
USA: CAL TB TB 117

**Fastness to light** EU: 5

**Fastness to rubbing** EU: Wet: 3 | Dry: 3



---

## Trevira CS+ | CS

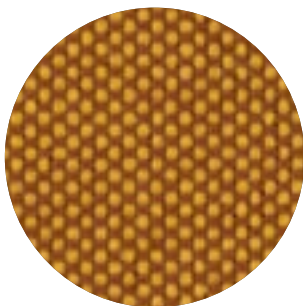

**Category A**

**Weight** 420 g/m<sup>2</sup> | 12.39 oz/yd<sup>2</sup>

**Composition** 100% Polyester, Trevira CS

**Abrasion resistance** 100.000 Martindale, 90,000 Wyzenbeek

**Flammability** BS 5852 part II: CRIB 5 | BS 7176 Medium Hazard  
USA: CAL TB 117 | M1 | B1 | EN 1021/1-2 | C1 |  
IMO Res. A652 (16)

**Fastness to light** EU: 6 | USA 5

**Fastness to rubbing** EU: Wet 4-5 | Dry 4-5

**Fastness to crocking** USA: Wet 5 | Dry 5





## Revive 1

kvadrat

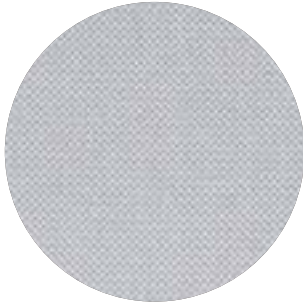

**Category A**

**Composition** 100% recycled polyester FR

**Weight** 430 g/lin.m

**Abrasion resistance** 60.000 Martindale rubs, EN ISO 12947

**Flammability** EN 1021-1/2 | DIN 4102 B1 | Önorm B1/Q1  
UNI 9175 1IM | US Cal. Tech. Bull. 117  
IMO A.652 (16)

**Fastness to light** Note 5-7, ISO 105-B02

**Fastness to rubbing** (ISO) dry 5, wet 4-5

**Pilling** Note 4-5, EN ISO 12945



## Revive 2

kvadrat

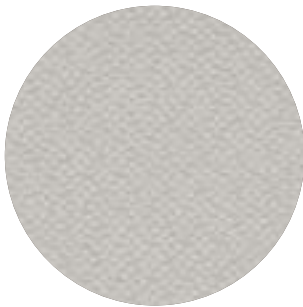

**Category A**

**Composition** 100% recycled polyester FR

**Weight** 420 g/lin.m

**Abrasion resistance** 45.000 Martindale rubs, EN ISO 12947

**Flammability** EN 1021-1/2 | DIN 4102 B1 | Önorm B1/Q1  
UNI 9175 1IM | US Cal. Tech. Bull. 117  
IMO A.652 (16)

**Fastness to light** Note 5-7, ISO 105-B02

**Fastness to rubbing** (ISO) dry 5, wet 4-5

**Pilling** Note 4-5, EN ISO 12945



## Velvet



**Category B**

**Composition** 100% PES

**Weight** 375 g/m<sup>2</sup> | 11.06 oz/yd<sup>2</sup>

**Abrasion resistance** > 100.000 Martindale

**Fastness to light** EU: 4-5

**Fastness to rubbing** EU: Wet 4 | Dry 4-5

**Pilling** EU: 4-5

## Terra



**Category B**

**Composition** 100% Pure New Wool

**Weight** 370 g/m<sup>2</sup> | 10.91 oz/yd<sup>2</sup>

**Abrasion resistance** 40.000 Martindale, 25,000 Wyzenbeek

**Flammability** EU: BS5852 CRIB 5 | BS5867 PART 2 : 2008 : TYPE B  
EN: 1021.2/2006 | USA: CAL TB 117

**Fastness to light** EU 5 | USA 5

**Fastness to rubbing** EU: Wet 4 | Dry 4

**Fastness to crocking** USA: Wet 4 | Dry 4



## Clara 2

kvadrat

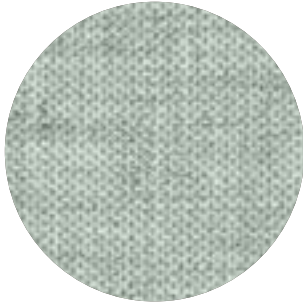

**Category B**

**Composition** 92% new wool, 8% nylon

**Weight** 400 g/lin.m

**Abrasion resistance** 80.000 Martindale rubs, EN ISO 12947

**Flammability** EN 1021-1/2 | BS 5852, ignition source 2-3 | DIN 4102 B2  
NF D 60 013 | UNI 9175 1IM | US Cal. Tech. Bull. 117, Sec. E  
NFPA 260 | IMO A.652(16)

**Fastness to light** Note 5-7, ISO 105-B02

**Fastness to rubbing** (ISO) dry 4-5, wet 4

**Pilling** Note 4, EN ISO 12945



## Remix 2

kvadrat



**Category B**

**Composition** 90% new wool, 10% nylon

**Weight** 415 g/lin.m

**Abrasion resistance** 100.000 Martindale rubs, EN ISO 12947

**Flammability** EN 1021-1/2 | BS 5852 part 1  
Önorm B1/Q1 | NF D 60 013 | UNI 9175, 1IM  
AS/NZS 1530.3 | Cal. Tech. Bull. 117-2013  
NFPA 260 | IMO FTP Code 2010:Part 8

**Fastness to light** Note 5-7, ISO 105-B02

**Fastness to rubbing** (ISO) dry 4-5, wet 4

**Pilling** Note 4, EN ISO 12945



## Tartan



**Category C**

**Composition** 100% Pure New Wool

**Weight** 475 g/m<sup>2</sup>

**Abrasion resistance** 30.000 Martindale

**Flammability** EU: BS5852 CRIB 5 | BS5867 PART 2 : 2008 : TYPE B  
EN 1021.2/2006 | USA: CAL TB 117

**Fastness to light** EU: 5 | USA: 5

**Fastness to rubbing** EU: Wet: 4 | Dry: 4



## Hero

kvadrat

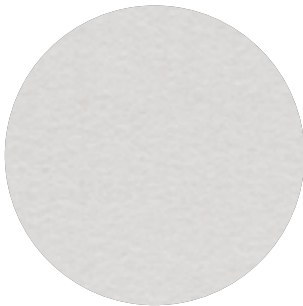

**Category C**

**Composition** 96% new wool, 4% nylon

**Weight** 580 g/lin.m

**Abrasion resistance** 45.000 Martindale rubs, EN ISO 12947

**Flammability** EN 1021-1/2 | DIN 4102 B2 | NF D 60 013  
UNI 9175 1IM | US Cal. Bull. 117-2013 | NFPA 260  
IMO A.652 (16)

**Fastness to light** Note 5-6, ISO 105-B02

**Fastness to rubbing** (ISO) dry 4-5, wet 4-5

**Pilling** Note 3-4, EN ISO 12945



## Tonus 4

kvadrat



**Category** D

**Composition** 90% new wool, 10% Helanca

**Weight** 665 g/lin.m

**Abrasion resistance** 100.000 Martindale rubs, EN ISO 12947

**Flammability** EN 1021-1/2 | BS 5852 part 1 | DIN 4102 B2

Önorm B1/Q1 | NF D 60 013 | UNI 9175 11M

US Cal. Bull. 117-2013 | NFPA 260 | IMO A.652 (16)

**Fastness to light** Note 5-7, ISO 105-B02

**Fastness to rubbing** (ISO) dry 3-5, wet 3-5

**Pilling** Note 3, EN ISO 12945



## Tonus Meadow

kvadrat

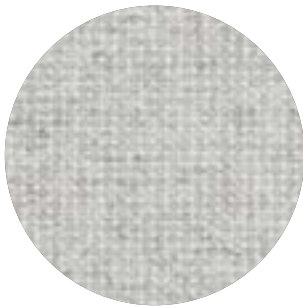

**Category** D

**Composition** 90% new wool, 10% Helanca

**Weight** 665 g/lin.m

**Abrasion resistance** 100.000 Martindale rubs, EN ISO 12947

**Flammability** EN 1021-1/2 | BS 5852 part 1 | DIN 4102 B2

Önorm B1/Q1 | NF D 60 013 | UNI 9175 11M

US Cal. Bull. 117-2013 | NFPA 260 | IMO A.652 (16)

**Fastness to light** Note 5-7, ISO 105-B02

**Fastness to rubbing** (ISO) dry 4-5, wet 4

**Pilling** Note 3, EN ISO 12945



## Memory 2

kvadrat

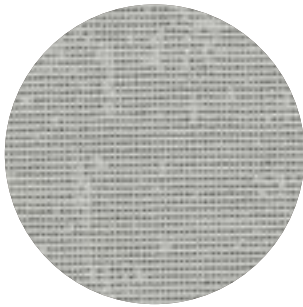

**Category** E

**Composition** 100% Trevira CS

**Weight** 700 g/lin.m

**Abrasion resistance**

35.000 rubs acc. to the Martindale method, EN ISO 12947

**Flammability** EN 1021-1/2 | DIN 4102 B1 | Önorm B1/Q1

NF D 60 013 | NF P 92 507 M1 | UNI 9175 11M

UNI 9177 classe 1 | US Cal. Tech. Bull. 117

IMO A.652 (16)

**Fastness to light** Note 5-8, ISO 105-B02

**Fastness to rubbing** (ISO) dry 4-5, wet 4-5

**Pilling** Note 4, EN ISO 12945



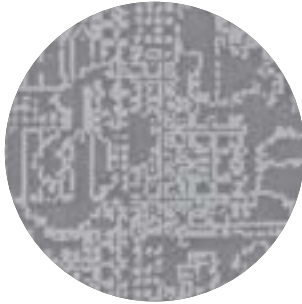

**Category** F

**Composition** 100% Trevira CS

**Weight** 760 g/lin.m

**Abrasion resistance**

App. 60.000 rubs acc. to the Martindale method, EN ISO 12947

**Flammability** EN 1021-1/2 | BS 5852 crib 5 | BS 5867 part 2 type B  
DIN 4102 B1 | Önorm B1/Q1 | NF D 60 013  
UNI 9175 1IM | US Cal. Tech. Bull. 117 | NFPA 701  
IMO A.652 (16)

**Fastness to light** Note 5-7, ISO 105-B02

**Fastness to rubbing** (ISO) dry 4-5, wet 4-5

**Pilling** Note 4, EN ISO 12945



# Leather Vintage



**Raw material** European New Zealand Bullhides

**Surface** Pure Aniline

**Flammability** EU: EN 1021.1 - BS5852 PART 1 (cigarette)  
EN 1021.2 - BS5852 PART 1 (match)  
USA: CAL TB 117

**Fastness to light** EU: 3 Blue Scale (72h exposition)

**Fastness to rubbing** EU: Wet: 20 cycles/4 | Dry: 100 cycles/4  
Sweat: 20 cycles/4

**Strenght** Tear resistance: >20N or 10N/mm thickness

Tensile: >20N/mmq

Elongation: 40-70%

# Finishes

---

## Wood

for Base and Tabletop



Ash Natural

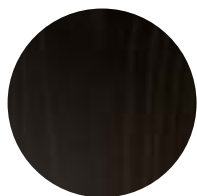

Ash Black Stained



Ash White Wash

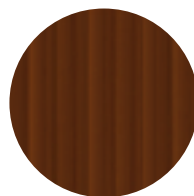

Walnut



Oak



Ash Lacquered  
Blue\*

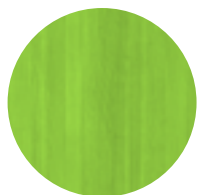

Ash Lacquered  
Green\*

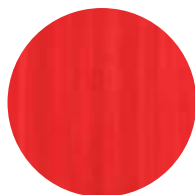

Ash Lacquered  
Red\*

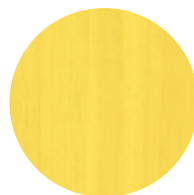

Ash Lacquered  
Yellow\*



Ash Lacquered  
White\*

\* Not available for Side Table, Side Table Large, Table

# Dimensions

## Stool

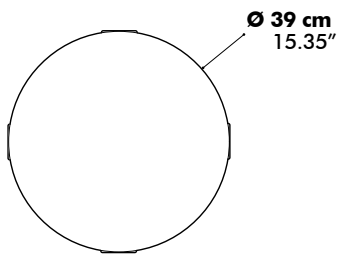
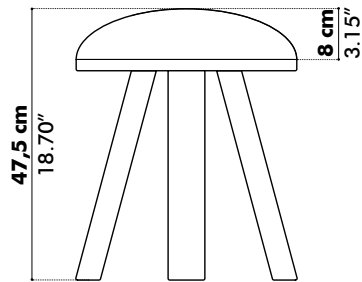

## Counter

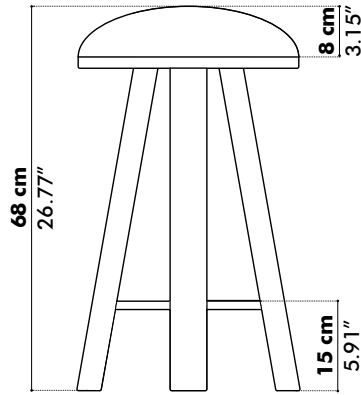

## Bar

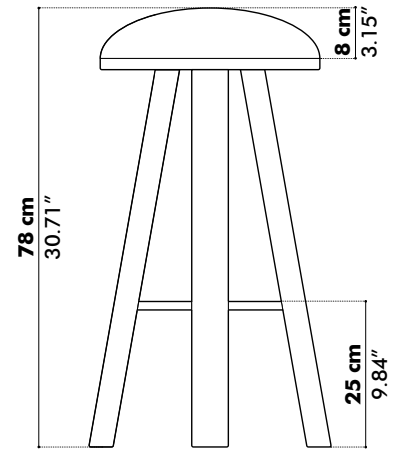

## Bench

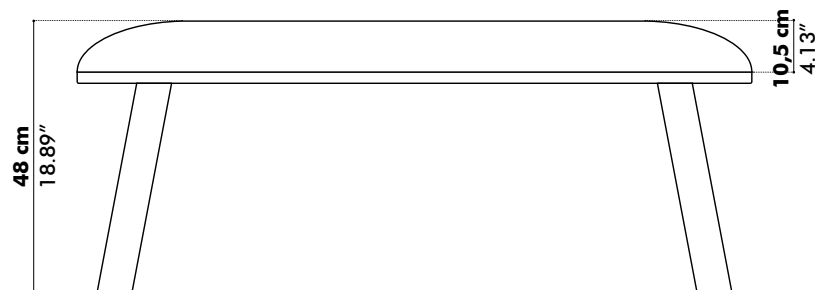
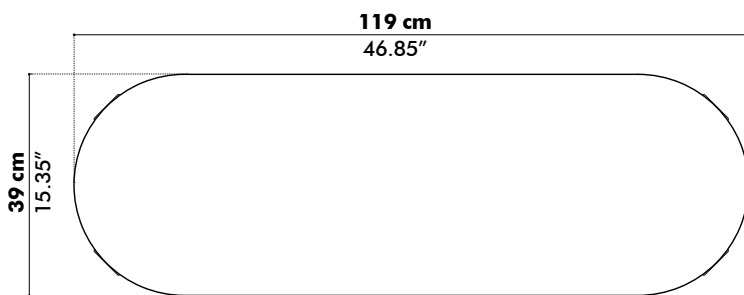

## Stool All Wood

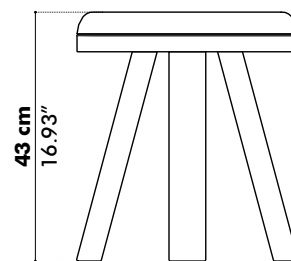
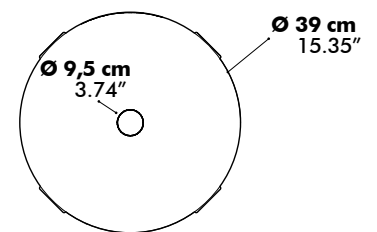

---

## Tile Small

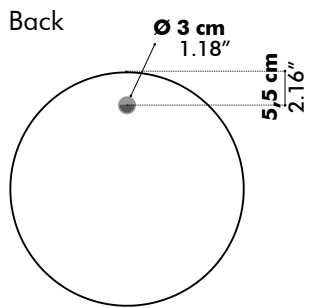
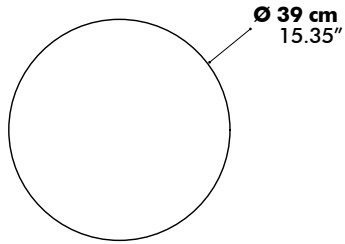

---

## Tile Large

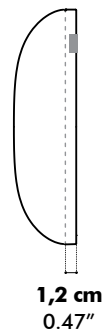
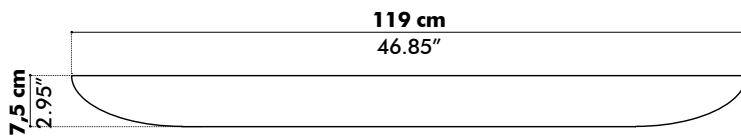
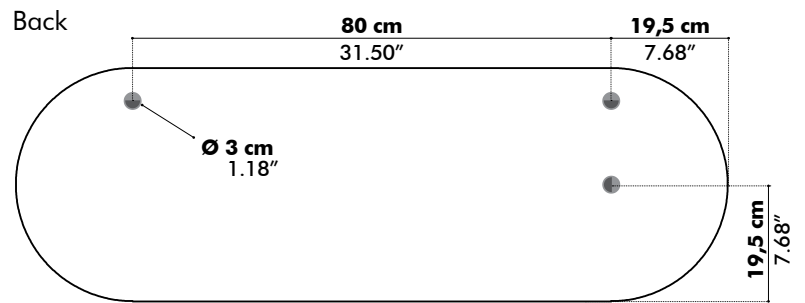
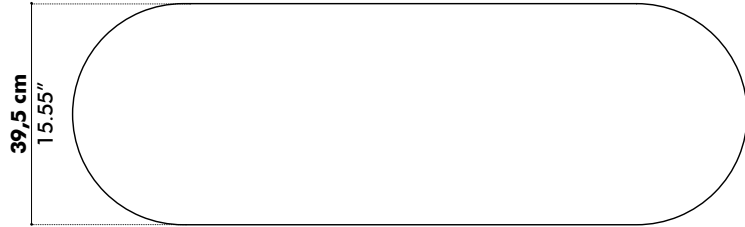

## Side Table

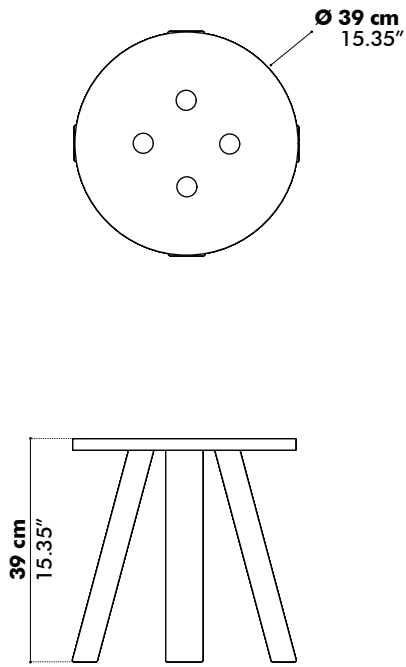

## Side Table Large

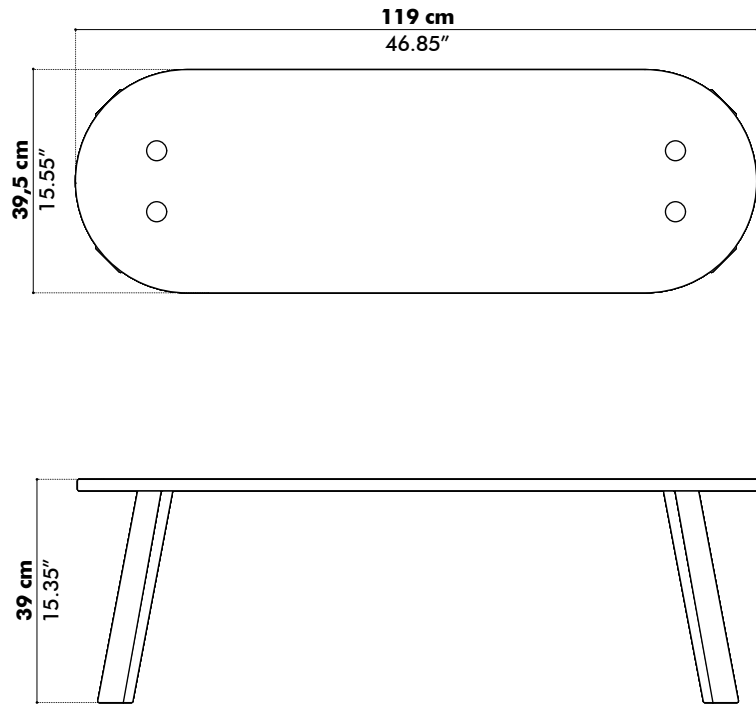

## Table

