

KEYPIECE. Design: EOOS.



Keypiece is the new conference table program for modern conferencing. It satisfies every demand: from cultivated business routine to the highest demands of the boardroom. Top-quality and variable as a well-thought-out system: top, beam, joint leg, glide – the structural parts of the range. Different table shapes correspond to the varying framework geometries. Whether round, boat-shaped, trapezoidal, square or rectangular - Keypiece carries its top in every imaginable variant.

Product description

Table tops

Shape: rectangular, boat shape, trapezoidal, square and round. The maximum width of an oblong table top is 280 cm. Larger table versions consist of several table tops.

Table top and edge versions

Three table top versions are available.

Basic:

Micro chipboard core with straight edge.
Thickness: 25 mm.

Surfaces:

- melamine soft white with ABS ending.
- fine textured paint, paint white no. .03, HPL laminate, fenix® or veneers from price groups II and IV.



Advanced:

MDF core with chamfered edge.
Thickness: 28 mm bevelled to 10 mm.
Bevelled edge lacquered.

Surfaces:

- fine textured paint, paint white no. .03, HPL laminate, fenix®, linoleum,
- linoleum black with silver-coloured edge no. .71 and veneers from price groups II, IV, V, VI.



Soft:

MDF core with soft edge.
Thickness: 28mm. Lacquered bevelled edge with integrated edge protection.

Surfaces:

Available only in fine textured paint.



Table frame

Table frame consisting of:

- aluminium leg with integrated cable duct and synthetic cover. Leg positions: angled corner and middle legs. U-shaped conference tables have two inner corner legs.
- beam: aluminium profile extrusion
- joint: die-cast aluminium

Legs:

- highly-polished
- powder-coated black matt
- powder-coated bronze matt

KEYPIECE.

Accessories and plug management

Accessories:

- Cable ducts (for surcharge)
- Modesty panels for conference table systems (prices upon request).

Plug management:

All conference tables can be equipped with connectors.
Depending on table top version, various connectors are available. Cable management for power and data connection is possible through each leg.

Table top version Basic can be equipped with Connector Netbox Line/Point or Connector Netbox Combi.

Table top version Advanced can be equipped with other connectors.

Seat widths

To accommodate different chair widths, tables are scaled to three different seat widths (75, 80 and 85 cm). Please specify scale with the ordering number. You will find chair widths for Walter Knoll chairs in the *price list Export Seating*. The number of seats includes long and short sides.

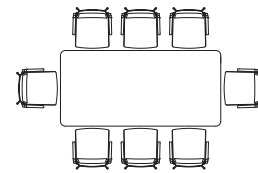

Ordering advice

The following criteria are required for planning customised table systems:

1. Room size
2. Number of seats, seat width 75, 80, 85 cm
3. Table top geometry
4. Table top surfaces
5. Plug management (number of power and data connections)
6. Integrated media technology

KEYPIECE.

Technical drawings and dimensions

Besucher-/Besprechungstische *Visitor's/Meeting tables*

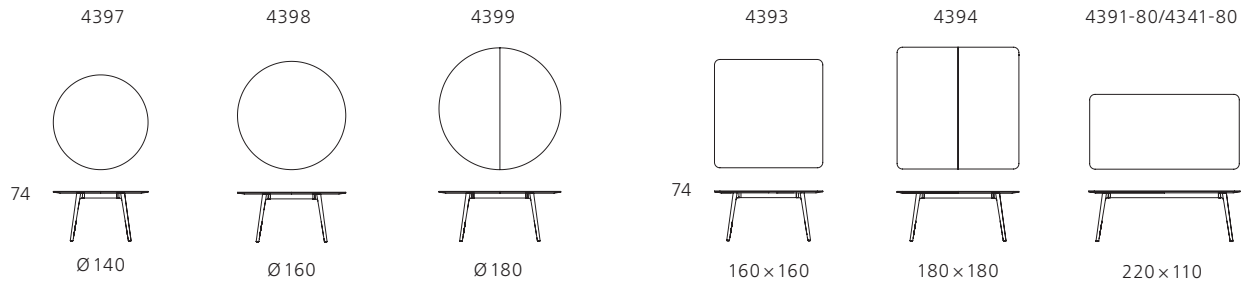

Konferenztische *Conference tables*

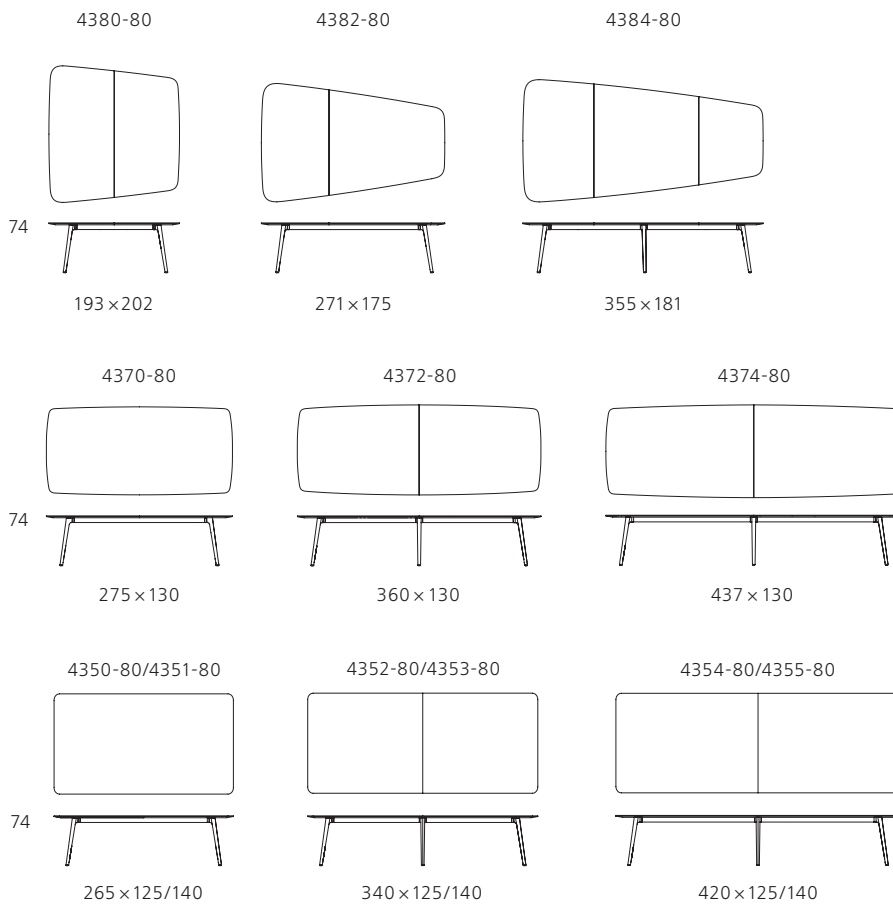

Alle Maßangaben in cm. *All dimensions in cm.*

All dimensions in cm.

Conference table systems

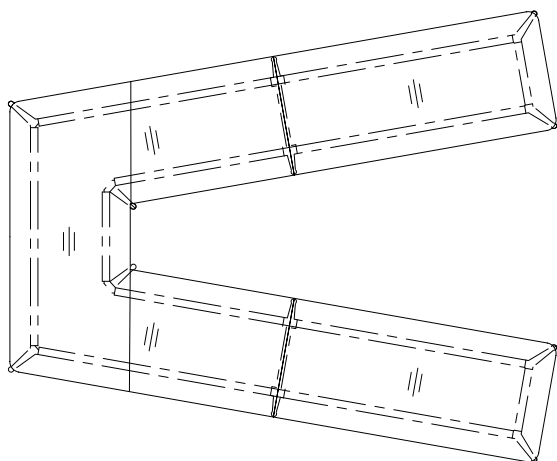
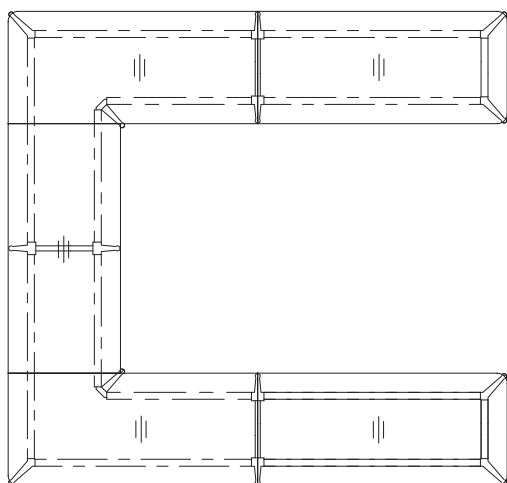

Note: Available on request. We would be pleased to help you plan your individual conference table system. Please contact the Walter Knoll back office.

Meeting tables/ visitor's tables

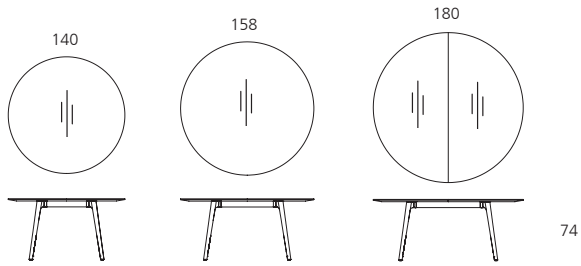

Conference tables

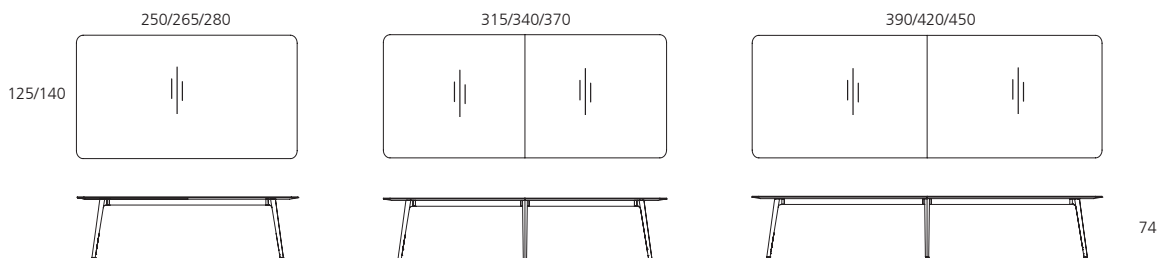
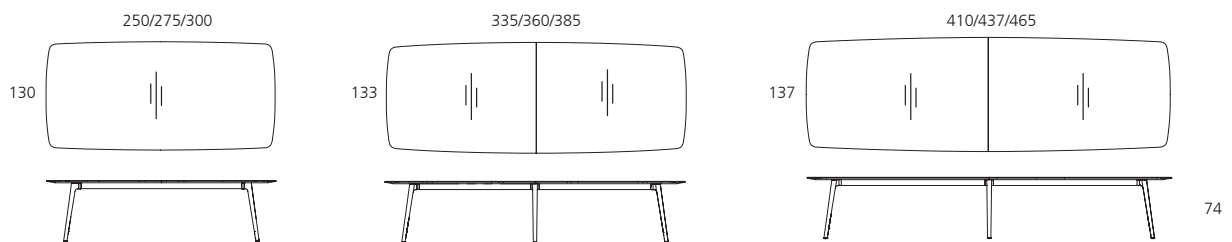
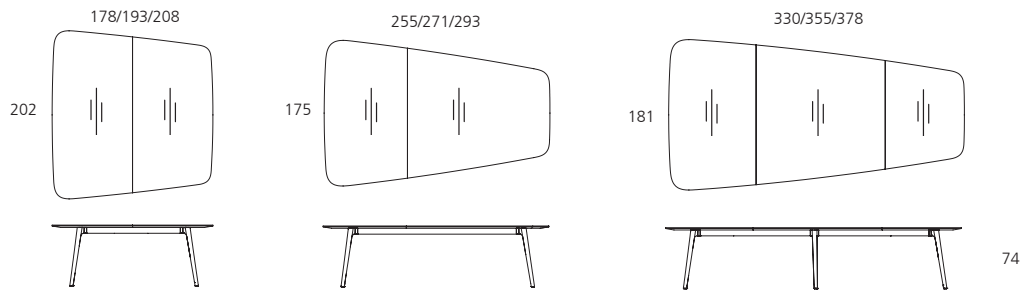

Note: Please contact the Walter Knoll back office for technical measurements.